

COCOON

S A F A R I
DENTAL

USER MANUAL

| Model: SAF-Cocoon F (Focus)
| Version 1.2





More Safety
More Convenience
More Durability

Table of Contents

Table of Contents	3
1 General Information.....	4
1.1 Notice	5
1.2 Manufacturer & User Obligations.....	6
1.3 Symbols	7
1.4 Standards & Classifications	11
2 Safety Precautions.....	13
2.1 Radiation Safety	14
2.2 Cleaning Safety	15
2.3 Storage & Transportation	16
2.4 General Warnings/Checks/Cautions.....	17
3 Getting Started	19
3.1 Intended use/ Prohibition of use.....	20
3.2 Product Composition	21
3.3 Features & Specifications.....	22
3.4 Equipment Part View.....	24
4 Operation	28
4.1 Powering Up	29
4.2 Operating the Control Panel.....	30
4.3 Positioning.....	31
4.4 Battery Usage	33
4.5 Screen Setting	37
4.6 Exposure	39
4.7 User Guide	43
5 Troubleshooting	45
5.1 Inspection Checklist	46
5.2 Troubleshooting.....	47
5.3 Maintenance Schedule.....	48
6 Equipment Specifications.....	50
6.1 Technical Specifications	51
6.2 X-ray Tube Characteristics & Specifications	52
6.3 EMC Data.....	54
6.4 Product Warranty.....	57

1 General Information

1.1 Notice	5
1.2 Manufacturer & User Obligations	6
1.3 Symbols	7
1.4 Standards & Classifications	11

1.1 Notice

SAF-COCOON F is a Portable Handheld Dental X-RAY System.

This is a diagnostic device that can be used on pediatric and adult patients. It's designed for taking diagnostic intraoral dental X-RAY using a conventional film (F-speed or greater film), PSP (Phosphor plates), or digital sensors. This device is indicated for use by only trained and qualified dentists or dental technicians.

This manual contains instructions, procedures, technical drawings and description for the SAF-COCOON F. Do not operate this device until you have read and reviewed this accompanying user manual completely.

SAF-COCOON F complies with the DHHS Radiation Performance Standard in 21CFR Subchapter J. Refer to the Certificate of Conformance accompanying your device for verification.

SAF-COCOON F is a trademark registered by Dexcowin Co., Ltd in Korea and other countries.

SAF-COCOON F includes the United States Patent No. 11185300.

For further information not covered in this manual and any incidents concerning the device, please report it to the manufacturer at:

Safari Dental Inc.

Email: sales@safaridental.com

Phone: 450 433-5754 / 1 800 567-0013

Fax: 450 433-5987

1.2 Manufacturer & User Obligations

1.2.1 Manufacturer's Liability

The manufacturer of this device assumes responsibility for the safe and regular operation of this device when:

- The approved replacement parts are used.
- All maintenance and repairs are performed by an authorized distributor/manufacturer.
- Using this equipment correctly according to the user manual.
- The equipment damage or malfunction is not the result of an error on the part of the user.



RADIATION HAZARD

This X-RAY unit could be dangerous to patients and operators unless safe exposure factors, operating instructions, and maintenance schedules are observed

1.2.2 User Obligations

The user must perform periodic tests at regular intervals to ensure safety. These tests must be performed per state and local X-RAY safety regulations.

The user must perform regular inspection and maintenance of the mechanical and electrical components of this equipment to ensure safe and consistent operation (IEC 60601-1).

The owner of this equipment must ensure to follow the safety precautions and Troubleshooting outlined in this manual.



CAUTION





Please do not operate this device before reading the manual and its related materials.

1.3 Symbols



The following symbols are used throughout this manual. The symbols descriptions, as well as other necessary information, are listed below.

NOTE: Make sure to observe all safety and warning information based on their assigned symbols.









Symbols used in this manual

	<p>RADIATION HAZARD</p>	<p>Indicates a possible danger to users from exposure to radiation.</p>
	<p>WARNING</p>	<p>Indicates details of possible user damage or physical damage.</p>
	<p>CAUTION</p>	<p>Indicates details of possible body damage due to incorrect use of the product.</p>
	<p>CHECK</p>	<p>Indicates the necessary items that users should follow during product installation, operation, and maintenance.</p>

Symbols used on SAF-COCOON F's package

	<p>KEEP DRY</p>	<p>Indicates that the transported package should be kept away from rain or damp areas.</p>
	<p>FRAGILE</p>	<p>Indicates that the contents of the transported package can be damaged and should be handled with care.</p>
	<p>THIS SIDE UP</p>	<p>Indicates which side of the transported package should face upward.</p>

Symbols used on the device

	ELECTRICAL PROTECTION	Indicates Insulated patient application (Type B).
	RADIATION HAZARD	Indicates a radiation hazard.
	CAUTION	Indicates a hazard.
	REFER TO DOCUMENTS	Refer to the user manual and other accompanying documents.
	MANUFACTURER'S INFORMATION	Indicates the name and address of the manufacturer.
	DATE OF MANUFACTURE	Indicates the device's manufacture date in the form MM-YYYY.
	SERIAL NUMBER	This symbol houses the device's serial number.
	WASTE ELECTRICAL & ELECTRONIC EQUIPEMENT(WEEE)	This symbol Indicates the need for a separate collection of electrical and electronic equipment in compliance with the Waste Electrical and Electronic Equipment (WEEE) Directive. This symbol indicates that electrical and electronic equipment wastes must not be disposed as unsorted municipal waste and must be collected separately. Please contact the manufacturer or an authorized disposal company to decommission your equipment according to local regulations

1.3.1 Label Locations

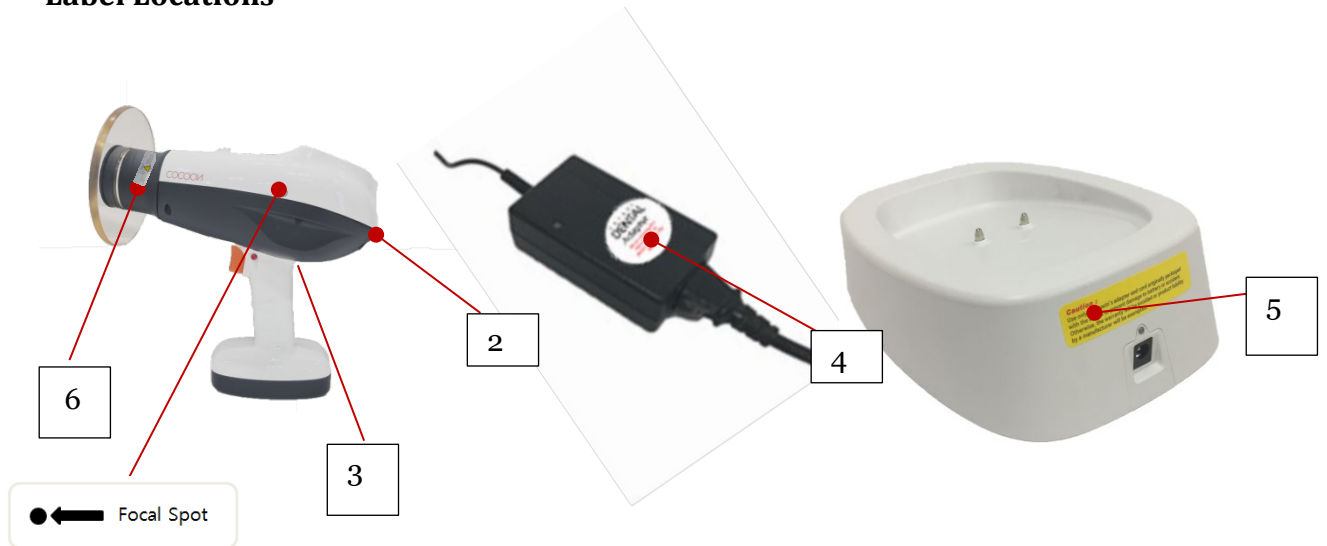

1. Generator(Inside) Label

Model : SAF-Cocoon F
 - Manufacturer : Safari Dental Inc
 - Rating : 70kV, 1.7mA
 - Output Power : 119W
 - Added Filtration : 0.8mmAl

X-Ray Tube
 - Manufacturer : TOSHIBA Corp.
 - Model : D-041
 - Focal Spot : 0.4mm
 - Inherent Filtration : 1.0mmAl

2. Safety Label

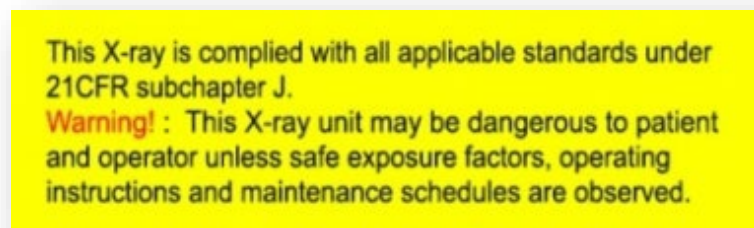

3. Main Label

Name : Portable Handheld X-Ray system

- Trade mark : Cocoon
- Model : SAF-Cocoon F
- Rating : 14.8 Vdc
- Tube voltage : 70 kV
- Tube current : 1.7 mA
- Total filtration : 2.3mm Al (Inherent filtration: 1.0mm Al)

MD

Safari Dental Inc.
 94D Boul, des Entreprises Boisbriand, Québec, Canada
 Tel : 450 433-5754 / Tel : 1 800 567-0013 / Fax : 450 433-5987

Made in Canada

4. Adapter Label



5. Charging Cradle Label

Caution :
Use only Safari Dental adapter and cord originally packaged with the device to prevent damage to battery or accident. Otherwise, the warranty will be voided or product liability by the manufacturer will be exempted.

6. Warning Label (REDR)



1.4 Standards & Classifications

SAF-COCOON F is designed and manufactured to meet the following standards:

- ◆ ISO 13485:2016 Medical devices - Quality management systems - Requirements for regulatory purposes (EN ISO 13485:2016)
- ◆ ISO 14971:2019 Medical devices - Application of risk management to medical devices
- ◆ EN 60601-1:2006 Medical electrical equipment – General requirements for basic safety and essential performance (IEC 60601-1:2005/AMD1: 2012)
- ◆ IEC 60601-1:2012, Medical electrical equipment – General requirements for basic safety and essential performance
- ◆ IEC 60601-1-2:2014 Medical electrical equipment - Part 1-2: General requirements for basic safety and essential performance - Collateral standard: Electromagnetic compatibility - Requirements and tests **[Rev1]**
- ◆ EN 60601-1-3:2008/A11:2016, Medical electrical equipment - Part 1-3: General requirements for basic safety and essential performance - Collateral Standard: Radiation protection in diagnostic X-RAY equipment
- ◆ IEC 60601-1-6:2010/AMD1:2013 Medical electrical equipment - Part 1-6: General requirements for basic safety and essential performance - Collateral Standard: Usability
- ◆ IEC 60601-2-28:2010
- ◆ IEC 60601-2-65:2012+AMD1:2017, Medical electrical equipment - Part 2-65: Particular requirements for the basic safety and essential performance of dental intra-oral X-ray equipment.
- ◆ IEC 62366-1:2015 Medical devices-part1: Application of usability engineering to medical devices.
- ◆ IEC62304: 2015 Medical device software – software life cycle processes.
- ◆ ISO 14155-1:2010 Clinical investigation of medical devices for human subjects
- ◆ EN ISO 15223-1:2016, Medical devices - Symbols to be used with medical device labels, labelling and information to be supplied - Part 1: General requirements
- ◆ EN1041:2008 Information supplied by the manufacturer of medical devices
- ◆ ISO 10993-1:2009 Biological evaluation of medical devices- Part1: Evaluation and within a risk management process
- ◆ ISO 17050-1:2010 Conformity assessment-supplier’s declaration of conformity – part 1: General requirements.
- ◆ 21 CFR Subchapter J

◆ Classifications



The FDA symbol granted this equipment complies with the applicable standards for Medical Devices under the 21CFR Subchapter I.

Protection against the ingress of water: Ordinary Equipment (IPX0)

Protection against electric shock: Class II equipment, Type B



2 Safety Precautions

2.1 Radiation Safety.....	14
2.2 Cleaning Safety.....	15
2.3 Storage & Transportation.....	16
2.4 General Warnings/Checks/Cautions.....	17

2.1 Radiation Safety



**RADIATION
HAZARD**

- This X-RAY unit could be dangerous to patients and operators unless safe exposure factors, operating instructions, and maintenance schedules are observed.
- A pregnant, or soon-to-be pregnant woman, and children must be advised before an X-RAY operation.
- X-RAY operators must pay attention to the status of patients in case of emergency.
- X-RAY operator must stop operating the device if a problem is detected.

Diagnostic Reference Level



CHECK

Procedure	Approx. effective radiation dose	Comparable to natural background radiation for:	Additional lifetime risk of cancer from examination
DENTAL			
Dental X-RAY	0.005mSv	1day	Negligible
Reference site			
http://www.radiologyinfo.org/en/safety/index.cfm?pg=sfty_xray			
➤ Diagnostic Reference Levels in Pediatrics, for standard five-year-old patients, expressed in entrance surface dose per image, for single views			

Diagnostic Reference Level in Pediatrics



CHECK

Radiograph	Standard dose for each 5year old patient [Unit: mSv]
Dental: Orthopantomogram	0.014
Dental: Intraoral	0.008
Reference sites:	
https://www.westmetrokidsdental.com/digital-dental-x-rays-and-your-child/	
http://www.imagegently.org/Procedures/Digital-Radiography	
http://www.fda.gov/Radiation-EmittingProducts/RadiationEmittingProductsandProcedures/MedicalImaging/ucm298899.htm	

2.2 Cleaning Safety



- Power off or remove the power supply from the base before cleaning.
- Do not clean the battery charger while it is plugged into an outlet.
- This device is not waterproof (IPX0).
- Do not use any liquid, wet cloth, or spray to clean this device.
- The warranty will be voided, and any product liability will be exempted in case of submersion failure.



This device is not a waterproof device (IPX0). Do not use any liquid, wet cloth or spray to clean this device. The warranty will be voided, or any product. Liability will be exempted in case of inundate complaints.



2.3 Storage & Transportation



WARNING

- To prevent unauthorized use, SAF-COCOON F must be stored securely when not in use.



CAUTION

- The device must be stored in a safe place with access by qualified persons only.
- The X-RAY section that is in direct contact with the patient should be cleaned with surface disinfectant frequently.
- Do not use the device close to heaters and heating devices.
- Do not disassemble. If the SEAL attached to the product is damaged, repair services may not be covered under warranty.
- Regular testing and repair should be performed by designated repair service centers only.
- Avoid the following conditions when storing and using the device.
 - Locations with lots of moisture
 - Locations with direct sunlight
 - Locations with lots of dust
 - Locations with high humidity
 - Locations with no ventilation
 - Locations with excessive salt
 - Locations with explosive chemical substances or gases



CHECK

- Avoid locations with high humidity or direct sunlight when storing.
- Avoid locations with lots of dust, slope, and dirt when storing.
- Transportation and storage conditions:
 - Transportation and storage temperature: -25 ~ 40 °C (-13 ~ 104°F)
 - Transportation and storage humidity: 10 ~ 95 %
 - Transportation and storage atmosphere pressure: 500 ~1060hPa

2.4 General Warnings/Checks/Cautions



- Do not modify the device without authorization from the manufacturer.
- When using the device, if radiation exposure safety regulations and operation-related guidelines are not followed, both patients and operators can be at risk.
- Only an authorized skilled technician or person can operate this device.
- Please use this device only for designated purposes.
- When using this device, if any irregularity is found, please stop using the device to ensure the safety of the patient.
- Please do not modify or alter the device during operation.
- Make sure a fire extinguisher is on-site in case of fire-related emergencies.
- Patients with pacemakers may experience the malfunction of their pacemakers while being X-rayed.
- Do not touch the product, power supply, or plugin with wet hands to avoid electrical shock.
- If there is any serious incident concerning the device, please contact the manufacturer (Safari Dental Inc.) by fax, e-mail, or the local authority.



- The device must be stored in a protective case. Critical damage may occur if placed in an unsafe area where it could drop or sustain an impact.
- Do not place the device on a high shelf or any narrow, unsafe place. If the device falls, it may harm the user or damage the machine.
- Do not store the device in a vehicle or any place where it could be easily stolen or improperly used. If the device must be stored in those locations, take precautions to ensure it is tightly secured.
- Please ensure not to exceed the maximum X-RAY exposure required for image diagnosis.
- Handle the device with care; do not use sharp objects or cause a severe impact on the device. Follow the instruction carefully and use for recommended applications only.
- Use only in the recommended temperature, humidity, and pressure.

- Do not let the device get wet or be exposed to liquids.
- Do not store the product in places with frequent temperature changes or direct sunlight for extended periods. In extreme temperatures, the high voltage generator's cooling and insulating oil can be shrunk, swollen, frozen, or overheated, causing critical damages to the device and its function.
- In case of device breakdown or failure, label each part properly and inform the designated professional at the repair service center of the issue you are experiencing.
- Patients should not touch the device. If they do so, it will be at their own risk.
- If the device is dropped, do not attempt to turn it on. Detach power supply and inform service center.
- When discarding product,



Indicate the need for separate collection of an electrical and electronic product in compliance with the Waste Electrical and Electronic Equipment (WEEE) Directive. This symbol indicates that electrical and electronic equipment wastes must not be disposed of as unsorted municipal waste and must be collected separately. Please contact the manufacturer or an authorized disposal company to decommission your equipment according to local regulations.



CHECK

- Read the user manual before operating the device for proper usage.
- Double-check parts of the device that comes in direct contact with patients.
- Use the device with a designated sequence with minimum exposure to get quality diagnostic images.
- Use the device at a clean location with good ventilation.
- Clean the device with a dry cloth. Do not wet the device.
- Regularly inspect the device for malfunctions.

3

Getting Started

3.1	Intended use/prohibition of use.....	20
3.2	Product Composition.....	21
3.3	Features & Specifications.....	22
3.4	Equipment Part View.....	24

3.1 Intended use/ Prohibition of use

SAF-COCOON F is intended for use only by trained or qualified dentists and dental technicians for adult and pediatric patients. The device is designed for taking diagnostic intraoral dental X-RAY using conventional film or digital sensors. It's intended for use in a hospital/ clinical environment.



Prospective User Requirements

Education: A licensed dentist or dental assistant, radiologist, and graduates of relevant bachelor's degree (national qualifications)

Knowledge: The operator must understand:

- ✧ The treatment and diagnosis of dental diseases.
- ✧ The functionality of this diagnostic device.
- ✧ Device connection, installation, and operation.
- ✧ This English instruction manual.
- ✧ The effects of the treatment and diagnosis of dental diseases using diagnostic medical radiation devices.
- ✧ The operation of the diagnostic devices.
- ✧ The contents of the user manual.

3.2 Product Composition

 <p>Main body</p>	 <p>Charging Cradle</p>	 <p>Charger & AC Cord</p>
 <p>Neck strap (Optional)</p>	 <p>Back scattered shield</p>	 <p>Product bag</p>
 <p>External battery & Connector gender(Optional)</p>		 <p>User manual & Warranty</p>

Preliminary checks



CHECK

- Make sure that the serial number on the warranty matches the device and carrying case's serial number.
- Inspect for damage; the lead lining must cover the entire interior surface.
- The trigger button should freely move in when pushed and out when released.
- The device should be smooth and free of scratches, damages, or nicks.

3.3 Features & Specifications

SAF-COCOON F is a dental portable X-RAY system that offers durability, safety, and convenience.

Functions for users:

- ✧ Exposure time set up by the type of patient or teeth
- ✧ Intuitive Graphic User Interface
- ✧ Radiation exposure interval's setting function
- ✧ Trigger use
- ✧ Automatic shut down
- ✧ Designed for user wrist protection

Specifications

CHARGER	Model name	BPL910S16F01
	Input	AC 100-240[V], 50/60 [Hz], 0.5 [A]
	Output voltage	DC 16.8V
	Output current	1.0A
BATTERY CHARGING CRADLE	Model name	Cradle
	Charging voltage	DC 16.8V
	Charging current	1.0A
	Discharge voltage (at the time of battery connection)	Vary depending on discharge condition
	Discharge current (at the time of battery connection)	Vary depending on discharge condition
	Size	270mm(L) x 132mm(W) x 195mm(H)

SAF-COCOON F Main Body	Model Name	SAF-Cocoon F
	X-RAY tube focal spot size	0.4 mm (0.0157 inch)
	Protection type	B type
	Grade for electrical shock	
	Waterproof rating	IPX0
	Mode of operation	Discontinuous operation
	Cooling method	Oil cooling method
	Total filtration	More than 2.3mmAl (inherent filtration: 1.0 mm Al)
	Input power	DC 14.8 V
	Target angle	12.5°
	Distance to target	Distance between target and focal spot > 18 cm (7 inch)
	Main body weight	2.35 kg (5 lb.) (including back scatter shield)
	Operating temperature	10 - 40°C (50 - 104°F)
	Operating humidity	30-75% RH, non-condensing
	Atmosphere pressure condition of use	700 ~ 1060 hPa
	Battery type	Embedded inside of the main body and not a removable battery type
	kV (fixed)	70kV
	mA (fixed)	1.7mA
	Power consumption	350 W
	Exposure time	0.05~1.0sec
Exposure time setting interval	0.01 sec	

3.4 Equipment Part View

Main Body

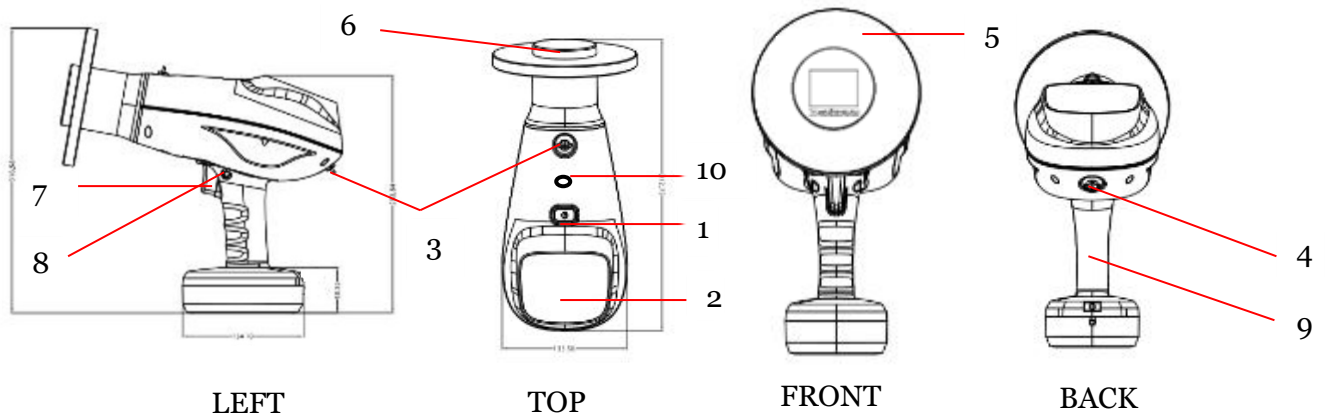

NO.	Item	Description
1	Power button	Power on/off button
2	OLED screen	Display screen
3	Neck strap ring	Connect the neck strap
4	External battery terminal connector	Connect the external battery
5	Back scatter shield	Shield from back scattered radiation
6	Exposure field	Limits the X-RAY exposure field
7	Trigger	Press this button for X-RAY exposure
8	Safety lock	Locks the trigger when the device is not in use
9	Handle	Helps to hold the device firmly when using the system
10	Aiming light Button	Pinpoints the exposure area

OLED Display Screen



NO.	Item	Description
1	Detector type selector	Selects the type of detector
2	Patient type selector	Selects the type of patient
3	Teeth type selector	Selects the type of teeth
4	Control panel	Selects parameters and changes its settings
5	Exposure lamp indicator	Indicates the X-RAY exposure status (Ready: Green/ X-RAY on: yellow)
6	Battery status indicator	Indicates the current state of the battery.
7	Lock indicator	Indicates lock of X-RAY exposure.
8	Exposure status indicator	Indicates the current state of the device.
9	Selected parameter indicator	Indicates which selected parameter is currently being set.
10	Exposure time	Indicates X-RAY exposure time

Radiation Field

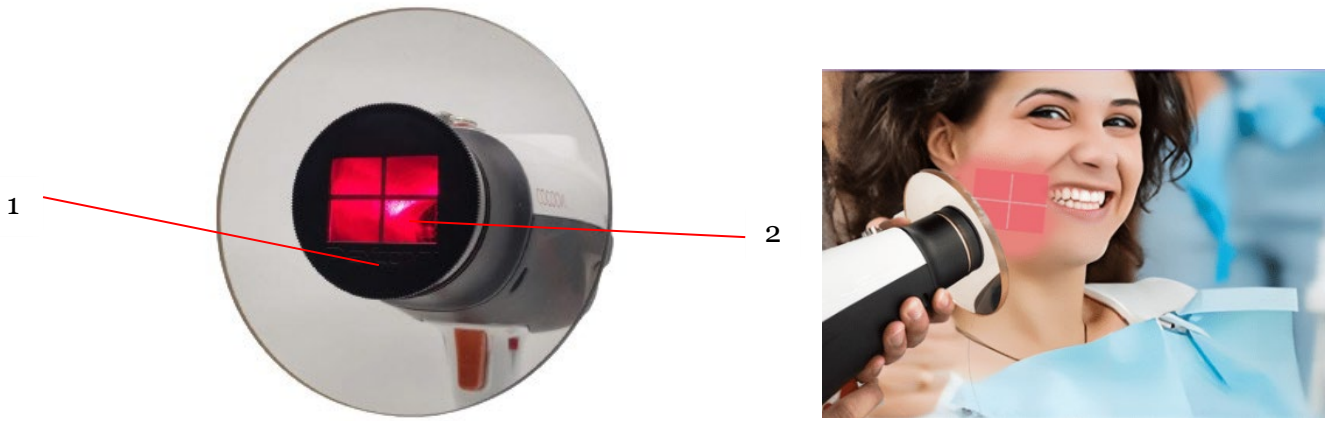

NO.	Item	Description
1	Rotary Plate	Pinpoints the position to X-RAY
2	Exposure area	Indicates area for exposure using AIMING LIGHT

Charger

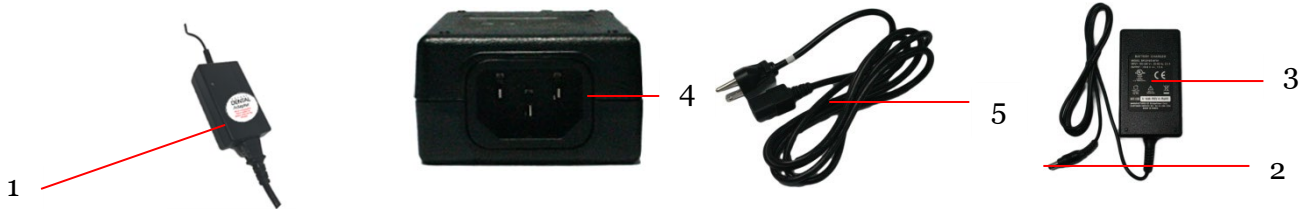

NO	Item	Description
1	Output indicator lamp	Displays the current output status.
2	Power charging jack	Supplies DC output power from the adapter.
3	Charging adapter label	Lists the model's name, input/output conditions, certification, serial number, etc.
4	AC input connector	Connects the AC input of the power cord.
5	AC power cord	Connects external AC power.

Battery Charging Cradle



NO	Item	Description
1	Charge terminals	Connects the output terminal of the battery pack to the charging terminals of the charging cradle to charge the battery.
2	Charge indicting LAMP	Indicates the status of the cradle when charging or charge completed using different colors (red: charging, green: charge completed).
3	DC input connector	Receives charging power from the charging adapter

External battery (optional)

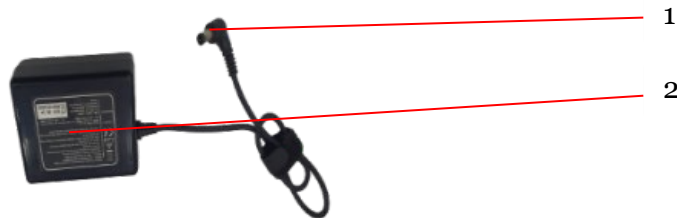

NO	Item	Description
1	Output terminal jack	Supplies DC output power from the external battery. Its length is over 14.5 inches.
2	Battery label	Lists the model name, input/output conditions, certification, serial number, etc.

4

Operation

4.1	Powering Up.....	29
4.2	Operating the Control Panel.....	30
4.3	Positioning	31
4.4	Battery Usage.....	33
4.5	Screen Setting.....	37
4.6	Exposure Process.....	39
4.7	User Guide.....	43

4.1 Powering Up

- ① Turn on the device by following this image.



- ② After pressing the power button at the top of the main body for 1 second, a green light should appear around the button, along with a buzzer sound. The display screen will turn on with the manufacturer's logo



- ③ When the logo disappears, the main (X-RAY) control screen will display:

- ✧ Teeth type selector
- ✧ Patient type selector
- ✧ Detector type selector
- ✧ Exposure time indicator
- ✧ Battery status indicator
- ✧ Lock indicator
- ✧ Selected parameter indicator



CHECK

Fully charge the SAF-COCOON F battery. Press the POWER button to check the ON and OFF button status

4.2 Operating the Control Panel

At the main control screen, Detector type, Patient type, Teeth type, and Exposure time can be adjusted.

Each parameter is adjustable using the control panel as follows:

- A. To select the 'Adult' or 'Child' mode, Push the ◀ ▶ control panel to select the parameter and then the ▲ ▼ control panel to choose the type of patient.



- B. Touch the ◀ ▶ control panel to activate the teeth type parameter and touch the ▲ ▼ control panel to change the teeth type. When the teeth type is changed, the exposure time is changed accordingly.
- C. Touch the ◀ ▶ touch panel to activate the exposure time parameter and touch the ▲ ▼ touch panel to change the exposure time. When the exposure time is changed, the type of teeth is changed accordingly. When power is turned off, the most recent setting for exposure is stored in memory and redisplays when power is turned on again.
- D. Press the ◀ ▶ touch panel at the same time for 3 sec to activate/deactivate the lock mode.



CAUTION

X-RAY is generated only while the X-RAY exposure trigger is pressed. If the exposure trigger is released before the exposure buzzer sound ends, exposure stops immediately.



CHECK

With the device on, press the up and down arrows to check that the exposure time displayed on the OLED display changes appropriately.

4.3 Positioning

In-order to achieve a high-quality dental radiograph, take care to follow the radiograph processes below:

Patient Positioning

- ◆ Place the patient in bilateral symmetry to the chair.
- ◆ Make sure the patient's head remains still.
- ◆ It is recommended to set an exposure position about 15~30 ° from the patient's position, but the degree and position can be adjusted according to the user's convenience. However, the patient should not move while being exposed.

Film or Intra-Oral Sensor Positioning

- ◆ X-RAY generated by SAF-COCOON F can be detected by various detectors such as film, intraoral sensor (digital), and PSP (phosphor plates).
- ◆ Place a film or sensor behind the teeth and hold it with a finger or positioning device to keep the film or sensor still and not moving.
- ◆ In the case of using film or PSP, make sure it's not bent or twisted to avoid distortion of the images.
- ◆ Detectors should be placed parallel to the center of the focal spot

SAF-COCOON F Positioning

- ◆ The distance between the end of the cone and the patient must be within 18cm (7 inches) at least from the focal spot (X-RAY focus point).
- ◆ The target teeth should be located at the center of the cone to get the whole shape of the target teeth.
- ◆ Depress the trigger to operate exposure when the intraoral detector and SAF-COCOON F's cone are parallel with the teeth at the center of the cone.
- ◆ When holding the device, it is recommended to grip the handle with one hand and place the other on the underside of the exposure button and the cone as shown in the following figure



CHECK

Before the operator exposes an X-RAY, the position of the film, intraoral sensor, or PSP and SAF-COCOON F should be parallel. If the angle deviates, the image can be distorted.

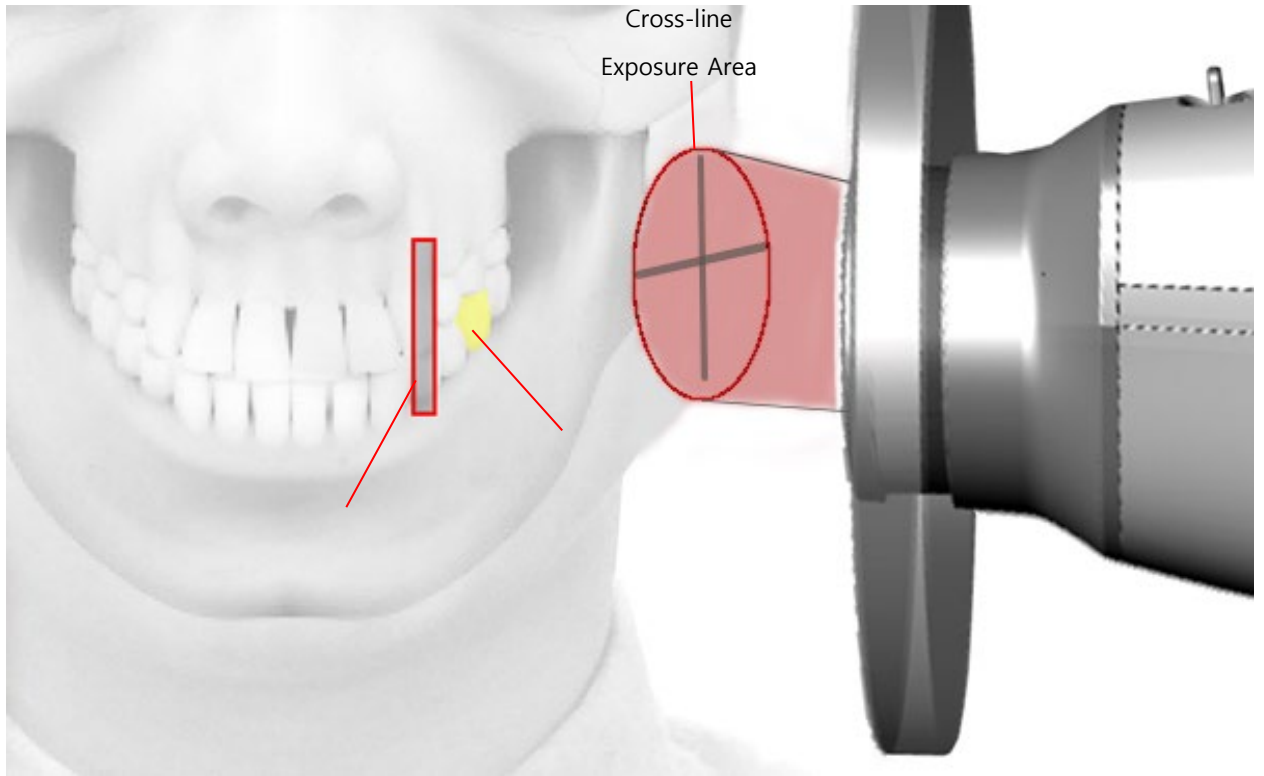

4.4 Battery Usage

There are two types of batteries used for the SAF-COCOON F device namely:

Non-Removable Internal Battery

This battery type is not detachable. It is embedded and not removable from the main body. Turn on the power to check that the device is working correctly.

If any problem occurs during troubleshooting, [see section 5.1 & 5.2](#)





External Battery

This battery is a removable external back-up battery. It is connected to the terminal on the main body at the rear of the machine just behind the main control panel.

Turn on the power to check that the device is working correctly.

If any problem occurs during troubleshooting, [see section 5.1 & 5.2](#)



 <p>NOTE</p>	<ul style="list-style-type: none"> ➤ A low battery will be indicated by a buzzer sound, OLED screen, Low battery indication lamp, and battery warning sound when power is on. ➤ The battery level displays on the upper right side of the main control screen are shown in Figure. When the battery level is between 0 ~ 15%, please charge the battery. <div style="text-align: center;">  </div> <ul style="list-style-type: none"> ➤ If the device is used without charging the battery, after the 'LOW' battery indicator is displayed, the battery warning message shown in the Figure below appears on the OLED screen for a few seconds, and then the device will forcibly turn off. <div style="text-align: center;">  </div>
---	---

 <p>NOTE</p>	<p>NOTE</p> <p>The battery is tested and fully charged before shipping to the factory. However, the battery should be fully charged before initial use to prevent battery function damage or being discharged to the lowest level. The battery should be charged in cases when it's unused or stored for a long time such as, three (3) months.</p>
---	--

Charging the Battery

Non-Removable Battery

- I. Connect the AC power cord to the charger.



- II. Connect the DC output connector to the cradle, and then insert the handle of the main body into the cradle.



NOTE

NOTE

Both the battery charging cradle and DC adapter's LED indicator turn red when power is connected. Make sure that the external back up battery is not attached when charging the internal battery.

- III. When charging is finished, the battery charging cradle and DC adapter's LED indicator will turn green.



External battery

I. Connect the AC power cord to the DC adapter.



II. Connect the external battery to the connector gender and then to the DC output connector. When the power is connected, the DC adapter's LED indicator will turn red.



III. When charging is finished, the DC adapter's LED indicator will turn green.



CAUTION

Use only Safari adapter and cord originally packaged with the device to prevent damage or accidental failure to the battery.

Use of the incorrect battery adapter or power supply will void the warranty and, product liability by the manufacturer will be exempt.



- After fully charging the battery, press and release the POWER button. The OLED display should illuminate, accompanied by a single audible signal.
- Check the battery level indication and remaining battery level on the upper right of the main screen.
- When the battery is low, a warning buzzer, a low battery indicator lamp on the OLED window, and a warning will sound.
- If the battery level gets low, it needs to be charged before use.

4.5 Screen Setting

Entering the Screen Setting

Press ▲ ▼ touch panels at the same time for 3 seconds to enter the screen setting.

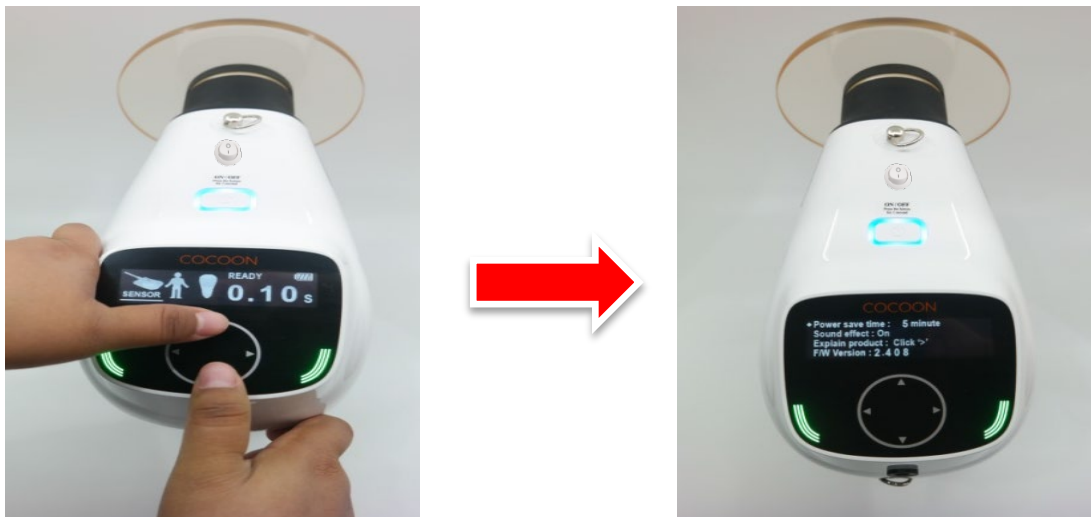

Move through the menu using the ▲ ▼ touch panel, and select one by touching the ► touch panel. To go back to the previous setting screen, press the ◀ touch panel.

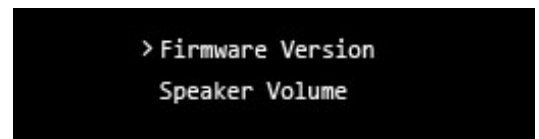
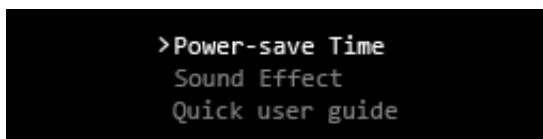

Power Save time

This indicates that the device turns off automatically if not used for the selected minutes. You can adjust time by touching the ▲ ▼ panels.

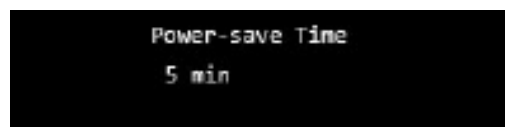

Sound effect

This Guides the function and status with a voice. You can choose between a Buzzer or Speaker by touching the ▲ ▼ panels and select the desired option by touching the ► panel. [*]Sign indicates which option is selected.

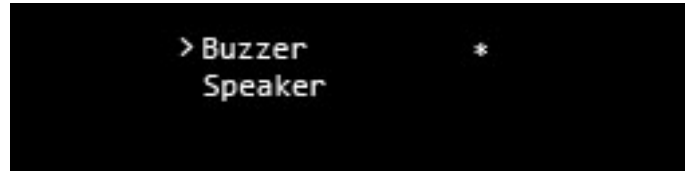

Quick user guide

A brief description of the product is played for about 3 minutes after touching the ► panel.

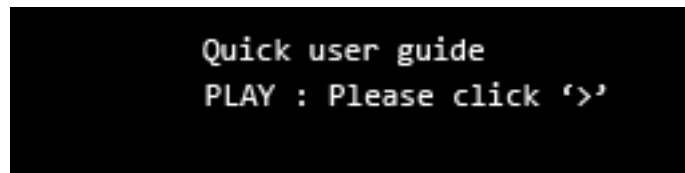

Firmware version

The current applied software version.

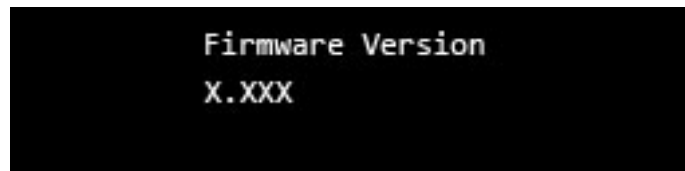

Speaker volume

Adjust the speaker volume level by touching the ▲ ▼ panel.

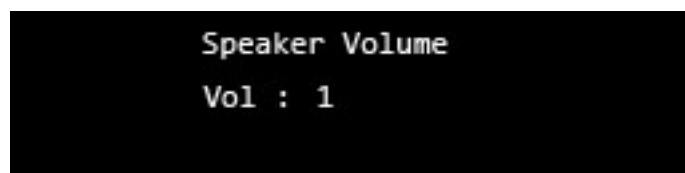

Powering off

To turn off SAF-COCOON F, press the POWER button for one second. (SAF-COCOON F will turn off automatically if not used for about 10 minutes.)



4.6 Exposure Process



CAUTION

The operator must let the patient know not to move during the whole exposure process.

SAF-COCOON F X-RAY exposure procedure is described below. Please correctly set up the position of the user and patient before x-ray exposure.

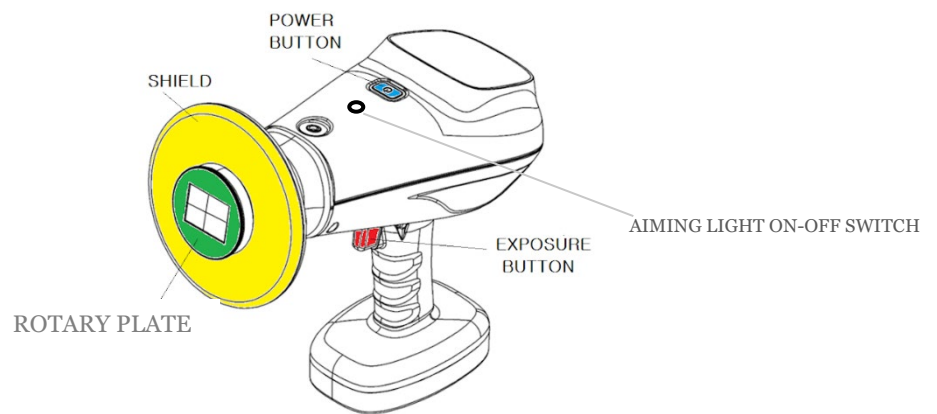

1. Press the POWER BUTTON to turn the device.
2. Set up the exposure time according to a recommendation or user's experience and preference for target teeth.
3. Place film, digital intraoral sensor, or PSP tightly inside the target teeth, and then press the AIMING LIGHT On-Off Switch to turn the light ON.
4. Point the main body toward the target teeth and then use the rotary plate to set position parallel with film, intraoral sensor, or PSP. Then press the EXPOSURE BUTTON to take an X-RAY image.
5. When pressing the trigger (exposure button):
 - An audible sound is produced and is followed by a buzzer sound. X-RAY is only generated when the buzzer sound is on.
 - After X-ray generation, the 'READY' sign on the upper main control screen changes to 'EXPOSURE.' The X-RAY indicating lamp on the device will change from green to yellow.

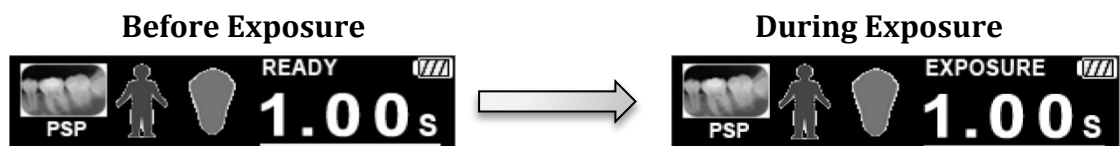

- During the exposure, the backscatter shield limits the area scattered radiation to the intended target.

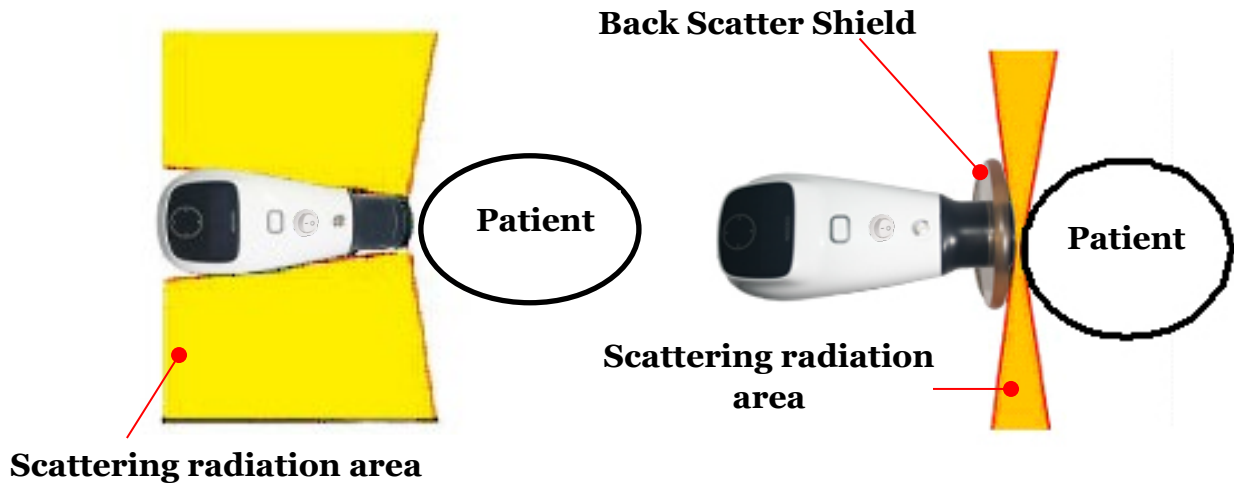

- After the exposure is finished, the 'EXPOSURE' sign disappears from the upper main control screen, the 'WAITING' sign is displayed, and then the LED turns off. When the 'READY' text returns, the lamp will turn green.

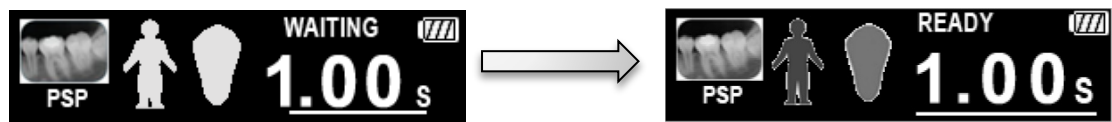



CAUTION

X-RAY exposes only during the buzzer sound while the trigger is being pressed but will stop when the trigger is released. (DMS method - Dead Man Switch)

4.6.1 Aiming Light Option Usage

1. Aiming Light is intended to help users to specify the exposure range.
2. Aiming Light consists of a rotary plate and a transparent glass cross-line, which is installed on the front of the cone.

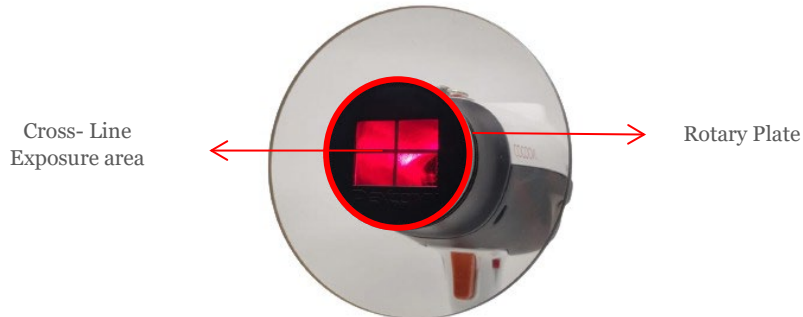

3. The Aiming Light On-Off Switch is located at the upper part of the device main body.



4. The method of use of each part is as follows:

- a) Aiming Light On-Off Switch operates independently for simply turning the Aiming Light on and off. This has no effect on SAF-Cocoon F(Focus) operation.
- b) Rotary plate rotates 360 degrees, the X-RAY is exposed in the square- shaped area.
- c) Before exposure, turn on the Aiming Light and adjust the rotary plate manually to focus the target area.



NOTE ON THE USE OF AIMING LIGHT







- a) The optimal recommended distance to X-RAY a desired tooth is 5cm or 2 inches between the skin and the edge of the cone. The aiming light accuracy between the light area and the actual exposed area is smallest at this distance.
- b) The source of light in Aiming Light is LED, which does not cause any harm to the patient, differently from laser pointer.
- c) Aiming Light uses the same power source as the main body, and if it is continuously turned on, it may cause overheating or power waste. Therefore, it is recommended to turn off the switch after operation.

Exposure Time Parameter

SAF-COCOON F's X-RAY exposure strength is 70 [kV], 1.7[mA], 0.05-1.0 [s]. Its exposure time can be adjusted between 0.05–1.0 [s].

Please refer to the table below to adjust the parameter for each teeth type.

Classification		Teeth types and exposure time				
Teeth						
Distance between cone and skin 18cm (7.08 in)	SENSOR	Adult	0.10 ~ 0.20	0.20 ~ 0.30	0.30 ~ 0.40	0.40 ~
		Child	0.05 ~ 0.15	0.15 ~ 0.25	0.25 ~ 0.35	0.35 ~
	PSP	Adult	0.20 ~ 0.30	0.30 ~ 0.40	0.40 ~ 0.50	0.50 ~
		Child	0.15 ~ 0.25	0.25 ~ 0.35	0.35 ~ 0.45	0.45 ~
	FILM (F-speed or greater)	Adult	0.30 ~ 0.40	0.40 ~ 0.50	0.50 ~ 0.60	0.60 ~
		Child	0.25 ~ 0.35	0.35 ~ 0.45	0.45 ~ 0.55	0.55 ~



CAUTION

Parameter set by teeth types can vary by sensor type and film, distance to patient, image preference. Please refer to it as a recommendation only.



CHECK

Set exposure time will be saved automatically when the device turns off. The last setting will stay until a new setting is attempted.

4.7 User Guide

1. Press the power button for 3 seconds. The OLED display should illuminate, accompanied by a single audible signal.

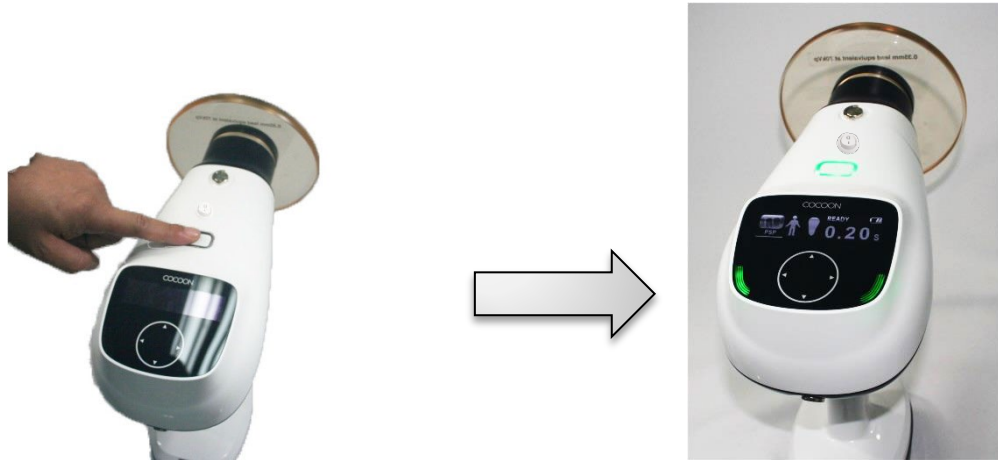

2. When the Main control screen displays, the operator can select parameters that the operator wants using ◀/▶ direction touch panel.

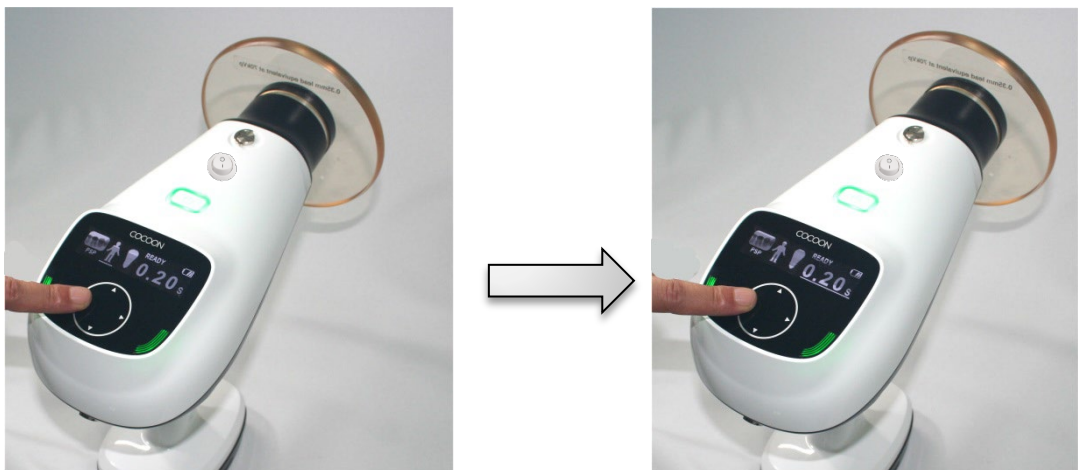

3. The Operator can change each parameter's values by using the ▲/▼ direction touch panel.



4. Check the safety lock position before X-RAY exposure. Then press the exposure trigger.



5. Press the ◀ ▶ touch panel at the same time for 3 seconds to activate/deactivate the lock mode.



6. The Position of film, intraoral sensor, or PSP and SAF-COCOON F's cone should be parallel (as shown in section 4.3). The target teeth should be located at the center of the cone. This is to get the whole shape of the target teeth.
7. Check the X-RAY image. If the image is abnormal, try the above procedure again. If there is no abnormality, press the power button for 1 second to turn off the device.
8. After using SAF-COCOON F, please store it in a safe place.



5

Troubleshooting

5.1	Inspection Checklist.....	46
5.2	Troubleshooting.....	47
5.3	Maintenance Schedule	48

5.1 Inspection Checklist

If an abnormality is found in the product, confirm the following items before service requests.

Steps to take for device malfunctions

Symptom		Steps to Take
Power defect	After turning on the power, both sound and OLED screen is not turned on.	<ul style="list-style-type: none"> ➤ Check that the battery is charged.
	The device turns off automatically while in use.	<ul style="list-style-type: none"> ➤ Check that the battery is charged.
Exposure defect	There is no exposure sound when X-RAY is exposed.	<ul style="list-style-type: none"> ➤ Check the status of the OLED display. It should be on. X-RAY is emitted when “exposure” is displayed on the main control screen only.
Others	DC adapter is not working.	<ul style="list-style-type: none"> ➤ Check that the DC adapter is connected to the AC power cord. ➤ Check that the AC power cord is connected correctly to the AC power outlet. The Correct input voltage of this device is AC 100-240V, 50/60[Hz] ➤ When the DC adapter is connected correctly to the power outlet, the LED at the upper part of the device lights up green. ➤ If the device does not operate despite a successful connection, disconnect it from the power outlet and contact an authorized service center.

5.2 Troubleshooting

Problem	Cause	Solution
Nothing lights up	The battery is low.	Connect to the battery charger.
No X-RAY emission	The generator is preparing an exposure, so there is no display on the screen.	Wait about 5 seconds for X-RAY exposure.
	Button or trigger defective.	Call a qualified service technician.
X-RAY emission works, but the image is too bright or completely white	Receptor defective.	Call a qualified service technician.
	Exposure is positioned incorrectly.	Adjust the position of the exposure according to the user manual.
	Exposure time is too short.	Increase the exposure time.
	Device defective.	Call a qualified service technician.
X-RAY emission works, but the image is too dark	Receptor defective.	Change the receptor or compare it with another receptor.
	Exposure time is too long.	Decrease the exposure time.
	Device defective.	Call a qualified service technician.

5.3 Maintenance Schedule

- ◆ Periodically review Section 3.1 Intended use / Prohibition for Use and product labeling to verify instructions for SAF-COCOON F.
- ◆ Users should regularly familiarize themselves with Section 2.4 General Warnings/checks/Cautions in the instructions.
- ◆ When a malfunction occurs, please refer to section 5.1 to inspect the item. Please contact the manufacturer/distributor immediately if the product seems to have abnormalities.

On-Going Check

- ◆ When turning on the product, confirm that the 'power on' sound plays and the regular initial screen is displayed.
- ◆ Exposure time settings are changed by using the directional touch panel. Confirm if time is changed per standard.
- ◆ When X-RAY is exposed, confirm that the buzzer sound plays and the exposure indicating lamp will turn yellow.
- ◆ After the device is powered on, check that the LED light is on and the device is operating right.

Annual User Check

Users should review the following materials yearly. Be sure to record their results in the Maintenance Log Sheets located at the bottom of this Section.

- ◆ Power button functionality verification- Press and hold the power button for 1 second. A beep will sound to signal that the machine has powered on. While the device is on, press and hold the power button for 1 second to shut the device down. Please check that the device has indeed turned off.
- ◆ Confirm that the status on the main control screen shows 'Ready' and that it blinks when the 'select' panel is touched.
- ◆ Dead-man button verification: Sets the exposure time to the maximum. Depress the exposure trigger to start the X-RAY exposure. Before the exposure time reaches the maximum, release the trigger. Check that the X-RAY exposure is stopped.
- ◆ Setting verification-Under the setting screen mode, check that the appropriate settings have been saved.
- ◆ DC adapter verification-Connect the DC adapter to an AC source, and make sure that the LED light turns on.

Annual Calibration

- ◆ SAF-COCOON F is factory calibrated and tested prior to release and there are no adjustment options. However, the optional checks listed below may be performed by a qualified technician as desired.

- ◆ Set up a calibrated Performance Meter (such as the Piranha554) according to the manufacturer's specifications to detect and report the following: X-RAY tube voltage, exposure time, and dose.
- ◆ Measurement Method: Final performance measurements are made using Piranha554. The exposure time is measured from the moment X-RAY are detected until they are no longer observed. This means a 90% cross setting is selected with no timer delays. Linearity is calculated per IEC60601-2-7, 50.102.2a
- ◆ Enable the SAF-COCOON F and, with the collimator perpendicular to the test detector, check exposures using the test detector. Compare results with the factory parameters indicated in the chart below.
- ◆ For results outside these parameters, discontinue use and contact Safari Dental Inc.
- ◆ This device should be calibrated once a year.

Acceptable ranges for the calibration

Test description	Acceptance limits	Exposure Time (ms)				
		50ms	100ms	300ms	500ms	1000ms
kVp Accuracy	70kV \pm 10%	64 ~ 77kV	64 ~ 77kV	64 ~ 77kV	64 ~ 77kV	64 ~ 77kV
Timer Accuracy	Set point \pm 10%	45 ~ 55ms	90 ~ 110ms	270 ~ 330ms	450 ~ 550ms	900 ~ 1100ms

Maintenance Log

Maintenance Test	Year 1	Year 2	Year 3	Year 4	Year 5	Year 6
	Date /Initial	Date /Initial	Date /Initial	Date /Initial	Date /Initial	Date /Initial
1. Power button						
2. Exposure sequence						
3. Remote button						
4. Dead-man button						
5. Setting						
6. DC adapter						
7. Calibration						

6

Equipment Specifications

6.1	Technical Specifications.....	51
6.2	X-RAY Tube Characteristics & Specifications..	52
6.3	EMC Data.....	54
6.4	Product Warranty.....	57

6.1 Technical Specifications

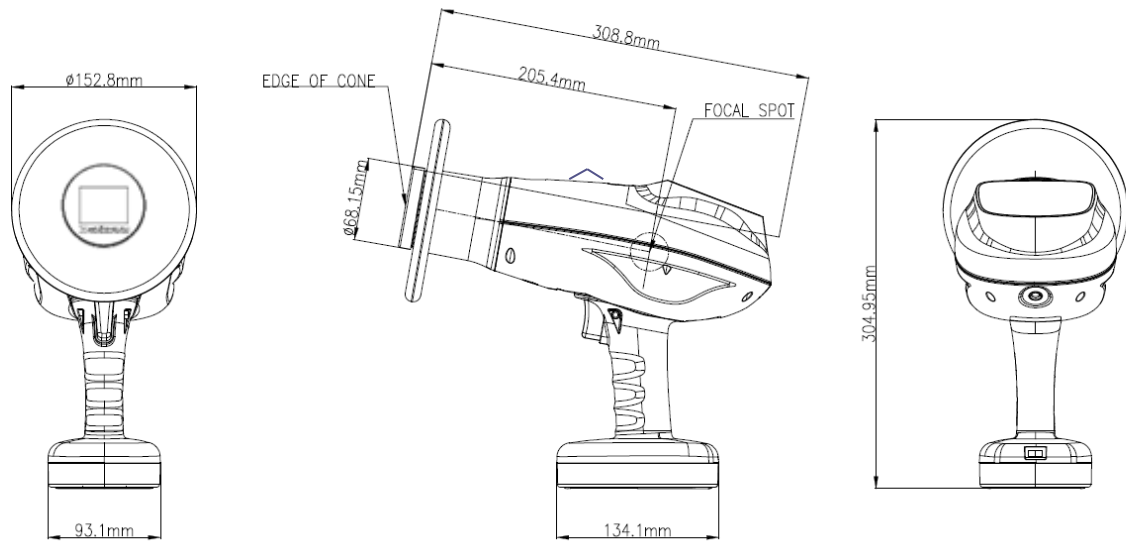

Item		Description
Saf-COCOON F Main Body	Dimension(mm)	308.8(L) x 304.95(H) x \varnothing 152.8
	Weight(kg)	2.17
High Voltage Generator	Model name	SAF-Cocoon F
	Input voltage	DC 14.8V
	Max output power	105 W
	Rating	70kV, 1.7mA
X-ray Tube D-041	Focal spot	0.4 mm (0.0157 inch)
	Target angle	12.5°
	Inherent filtration	At least 1.0mmAl
	Operating tube voltage	70kV

6.2 X-RAY Tube Characteristics & Specifications

Specifications

X-ray Tube model name	D-041
Manufacturer	TOSHIBA(Japan)
Operating Tube Voltage	70kV
X-RAY Tube Focal Spot	0.4
Nominal Anode Input Power (at 1.0s)	See rating chart
Constant Potential High-Voltage Generator	430W
Anode Angle	12.5 degree
Material	Tungsten
Inherent Filtration	At least 1.0 mmAl
X-RAY Coverage	φ70 mm at SID 200 mm
Anode Heat Content	4300 J
Maximum Radiographic Exposure Time	3.2 s

Characteristics

1. Tube characteristics

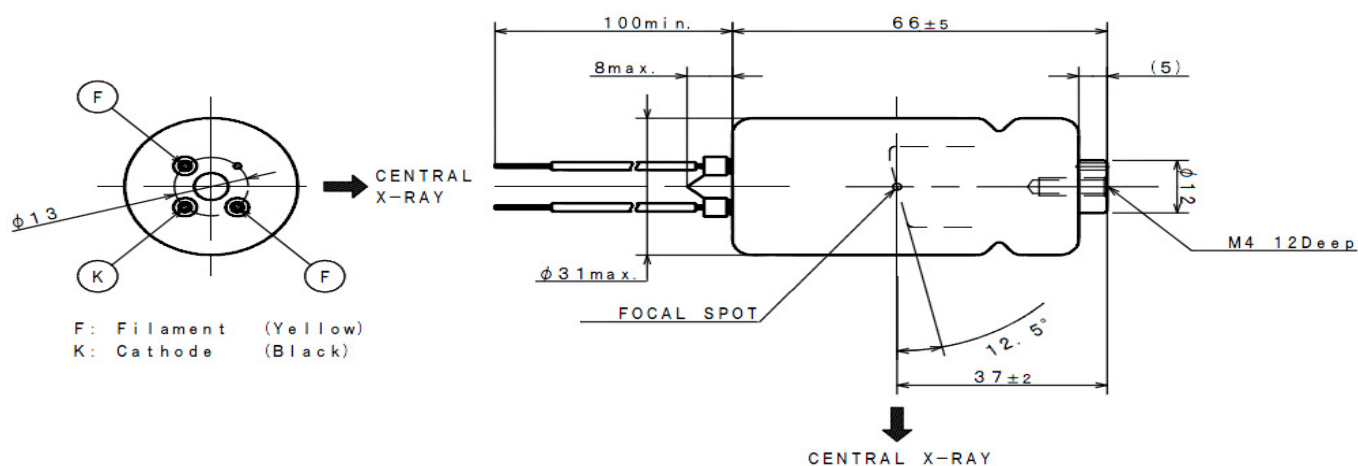

2. Maximum ratings chart

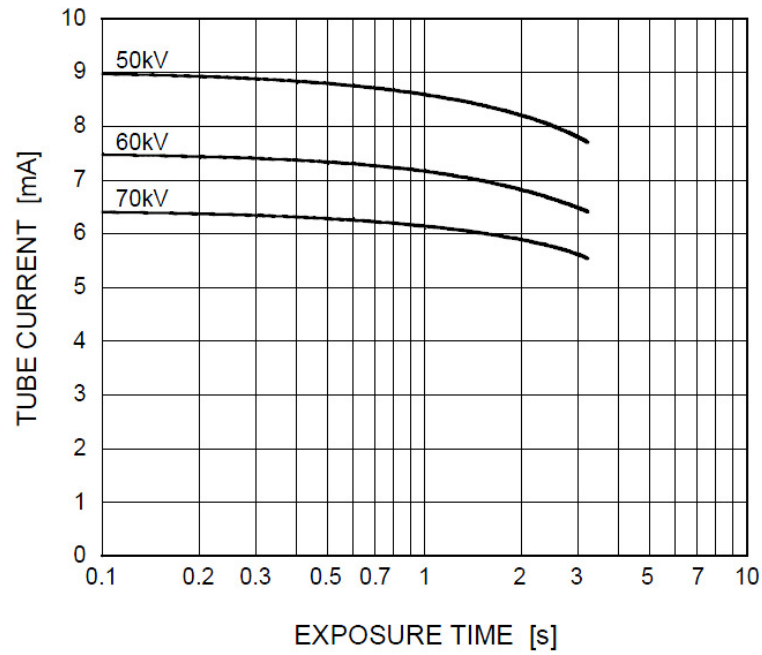

3. Emission & Filament characteristics

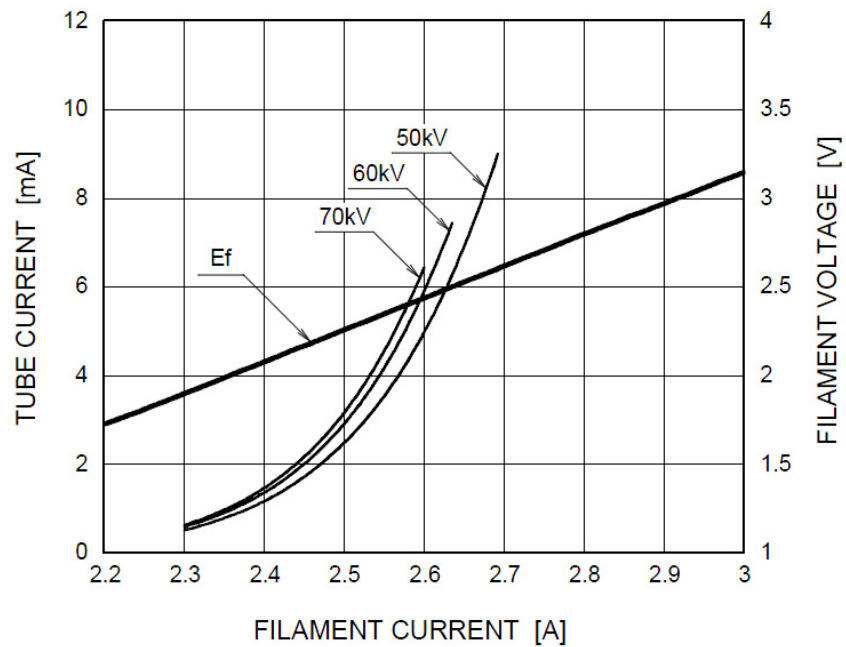

Note: This graph indicates typical characteristics.

6.3 EMC Data



- Other cables and accessories may negatively affect the EMC performance.
- Use of other accessories may result in non-compliance.
- SAF-COCOON F should not be used adjacent to or stacked with other equipment. If an adjacent or stacked use is necessary, SAF-COCOON F should be observed to verify regular operation.

- ◆ SAF-COCOON F has been tested to comply with the limits of medical devices in IEC/EN 60601-1-2. These limits are designed to provide reasonable protection against harmful interferences in a typical medical installation.
- ◆ Mobile RF communications equipment can affect medical devices.
- ◆ This equipment generates, uses, and can radiate radio frequency energy. If not installed and used per the instructions, it may cause harmful interference to other devices in the vicinity. However, there is no guarantee that interference will not occur in a particular installation. If this equipment does cause harmful interference to other devices, which is determined by turning the equipment off and on. The user is encouraged to try to correct the interference by one or more of the following measures:
 - Reorient or relocate the receiving device.
 - Increase the separation between the equipment.
 - Consult the manufacturer or field service technician for help.

Electromagnetic Emission

SAF-COCOON F is intended for use in the electromagnetic environment specified below. The customer or the user of the SAF-COCOON F should ensure that it is used in such an environment.

Emission test	Compliance	Electromagnetic environment - guidance
RF emissions – CISPR11	Group 1	SAF-COCOON F uses RF energy only for its internal function. Therefore, its RF emissions are very low and are not likely to cause any interference in nearby electronic equipment.
RF emissions- CISPR11	Class B	SAF-COCOON F is suitable for all establishments, including domestic establishments and those directly connected to the public low voltage power supply network that supplies buildings for domestic purposes.
Harmonic emissions IEC 61000-3-2	Class A	
Voltage fluctuations/flicker emissions IEC6100-3-3	Complies	

Electromagnetic Interference

- Radiated emission (electric field): 30 ~ 1000[MHz].
- Min. limit margin: 4.9dB at 1000[MHz].

Radiated Emission Data

Test	Frequency [MHz]	Antenna pol. [h/v]	Reading level [dbuv]	Correction (af+cl) [db/m]	Emission level	Limit(10m) [dbuv/m]	Margin [dbu/v]
Value	1000	H/V-	<2.0	30.1	<32.1	37	>4.9

Electromagnetic Susceptibility

Field	Contents			
Radiation field	Frequency range	Field strength	Modulation	Frequency step
	80 ~ 2500 [MHz]	3 [V/m] 10 [V/m]	AM 80 [%] 1 [kHz] sine wave	1 [%] / 3 step
Magnetic field	Test frequency	Field level (EMF)	Duration	Axis of orientation
	50 [Hz]	3 [A/m]	60 seconds each axis	X, Y, Z axis

6.4 Product Warranty

- ◆ Safari Dental Inc. offers a manufacturer warranty to all products for one year from the purchase date or installation date.
- ◆ This product is manufactured under strict quality assurance standards and inspection processes.
- ◆ If a breakdown occurs during the warranty period under normal usage, free repair service will be provided.
- ◆ If breakdowns are due to incorrect usage or negligence, a fee will be charged for repair services. This includes even if it is within the warranty period.
- ◆ The battery is excluded from this warranty or any extended warranty.
- ◆ We strongly recommend the battery to be replaced every year or at a minimum of every two years. Failure to do this will result in excessive heat or damage to the internal components of SAF-COCOON F.
- ◆ Failure by the customer to replace the battery at the recommended time interval will exempt Safari Dental Inc from any product liability for an accident caused by battery failure.
- ◆ Failure to use the correct supplied battery adapter will immediately void all warranties and exempt Safari Dental Inc. from any and all liability.
- ◆ If you have other questions or product related inquiries, please contact Safari Dental Inc. customer service center.

LOCATIONS	
Canada Office 94 D Boul. Des Entreprises, Suite D Boisbriand, Qc Canada Office: 450 433-5754 / Fax: 450 433 5987	

USER Manual

Model: SAF-Cocoon F (Focus)

Version 1.2



COCOON

*94D Boul, des Entreprises
Boisbriand, Québec, Canada*

Tel : 450 433-5754

Tel : 1 800 567-0013

Fax : 450 433-5987

Web site : www.safaridental.com

Email : sales@safaridental.com

S A F A R I
DENTAL